







-  Gross weight: 0.4kg/m
-  Dimmable: DALI, 0-10V, DMX, Triac
-  Installation Temp.: 0°C to +55°C
-  Ambient Temp.: -25°C to +55°C
-  Min. Bending : 80mm
-  Beam Angle : 120 degree



Eco-friendly PVC or Silicone Housing material optional



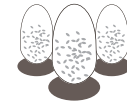
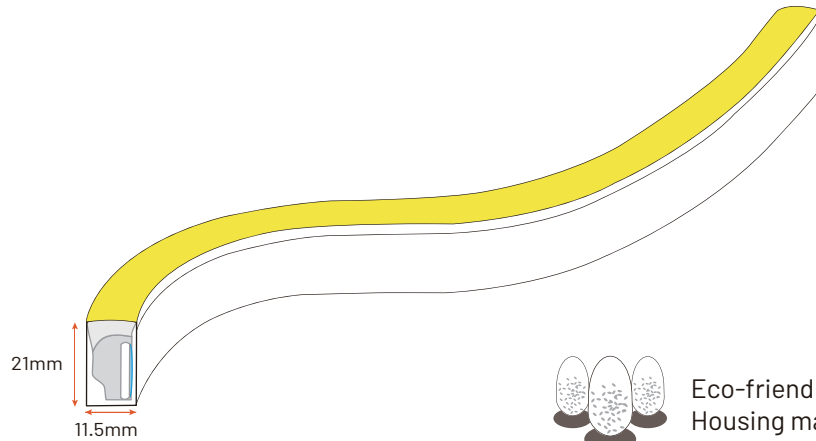





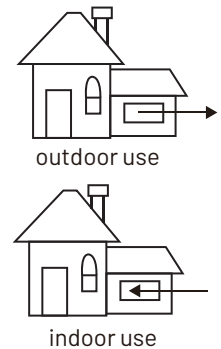



## Features

- Uniform and even light output
- Flat surface with 120 degree beam angle
- Dimmable with Dali, 0/1-10, DMX,PWM
- High Lumen output, up to 320lm/m for 12W version
- Full encapsulated with IP68 Connections
- High Reliability
- 3 or 5 Years warranty

## Applications

- Building facade, outline
- Cove lighting
- Billboard & Advertising
- Linear lighting
- Architectural Integration
- Wayfinding
- Outdoor Landscaping



-  Class 2
-  One Bin Only
-  IP68
-  LM-80
-  UV Protected
-  Corrosion Resistant
-  CE
-  UL LISTED
-  RoHS
-  IK08
-  Dirt Resistant
-  Saltwater Resistant

<b>VOLTAGE</b>	24V	<b>MAX LENGTH</b>	10M (SINGLE FEED) 20M (DOUBLE FEED)
<b>POWER CONSUMPTION</b>	12W/PM	<b>LIFE SPAN</b>	50 - 70,000 HRS
<b>LUMEN OUTPUT</b>	320LM/PM	<b>IP RATING</b>	IP68 SUBMERSIBLE UP TO 2M
<b>LED QUANTITY</b>	60 LED/PM	<b>HOUSING MATERIAL</b>	ECO PVC
<b>CUT UNIT</b>	100MM	<b>OPERATING TEMP</b>	-25 C to +55 C
<b>BEAM ANGLE</b>	120 DEGREE	<b>WARRANTY</b>	3 YEARS STANDARD, 5 YEAR OPTION

### ORDERING INFORMATION

<b>ITEM CODE</b>	F15A-CW	F15A-WW
<b>COLOUR</b>	5500K	3000K

## Construction

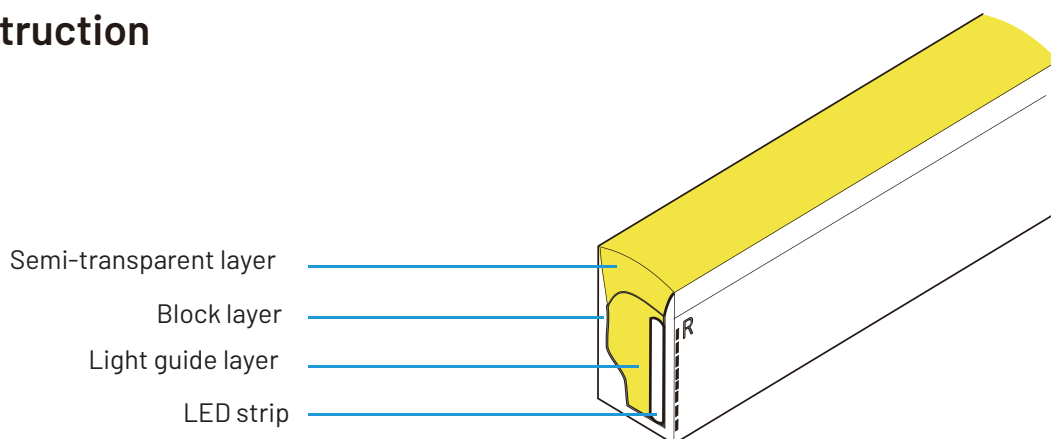

## Physical Specification

Light profile

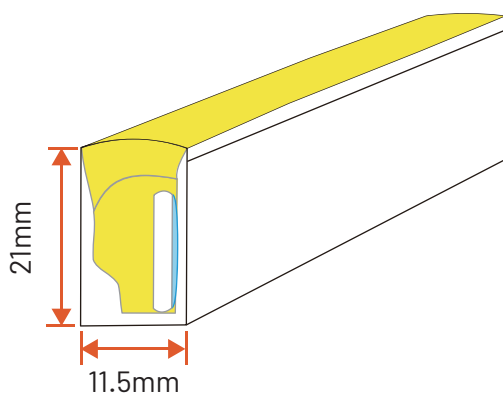

Bending direction

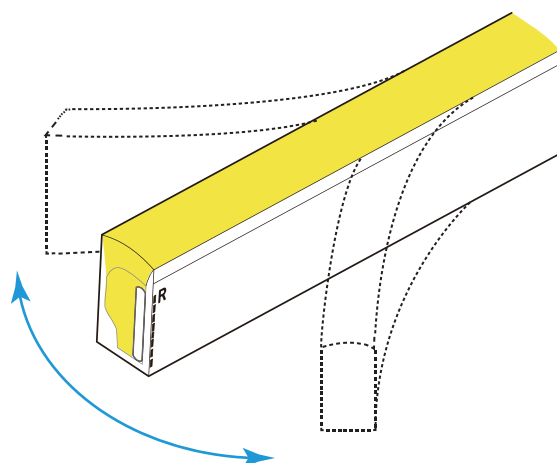

Min. bending diameter

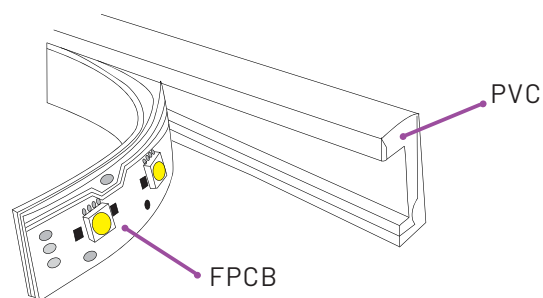
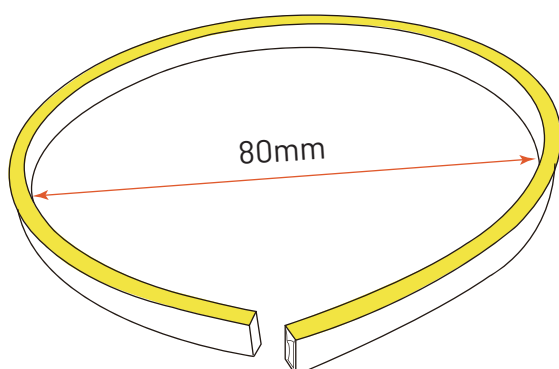

## Injection Moulded Connector (IP68 Factory Assembly Only)

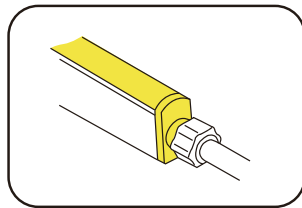

Direct Entry

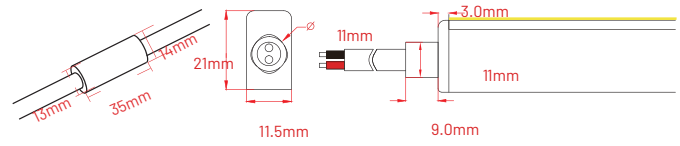
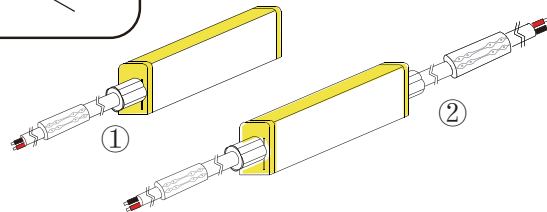

- ① F15A-M06
- ② F15A-M07

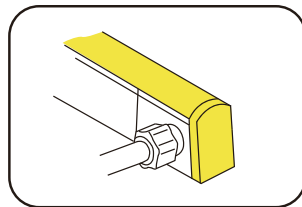

Side Entry

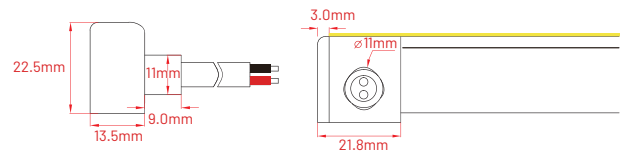
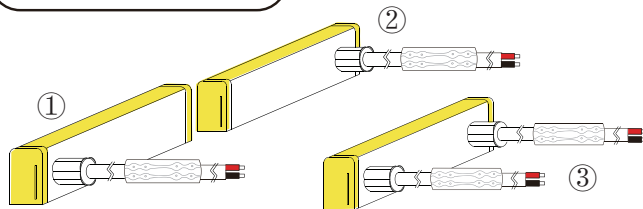

- ① F15A-M04
- ② F15A-M03
- ③ F15A-M05

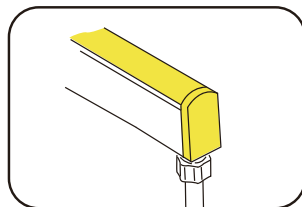

Bottom Entry

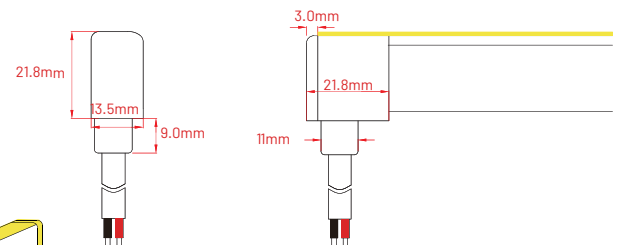
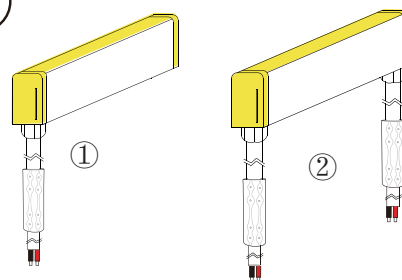

- ① F15A-M01
- ② F15A-M02

## Testing

ANSI Standard

Nominal CCT Categories (2200-6500K)

Nominal CCT	Target CCT & tolerance(K)	Target D <sub>uv</sub>	D <sub>uv</sub> Tolerance Range
2200K	2238±102	0.0000	Tx: CCT of the source for Tx<2870K 0.000±0.0060 For Tx≥2870K D <sub>uv</sub> (Tx)±0.0060 where $D_{uv}(Tx) = 57700 \times (1/Tx)^2 - 44.6 \times (1/Tx) + 0.00854$ Remark: 1) T <sub>F</sub> is chosen to be at 100K steps (2300,2400.....6400K) the ten nominal CCTs listed in table 1. 2) $\Delta T = 1.1900 \times 10^9 \times T^3 - 1.5434 \times 10^6 \times T^2 + 0.71648 \times T - 902.55$ 3) Same as in the DUV tolerance range
2500K	2460±120	0.0000	
2700K	2725±145	0.0000	
3000K	3045±175	0.0001	
3500K	3465±245	0.0005	
4000K	3985±275	0.0010	
4500K	4503±243	0.0015	
5000K	5029±283	0.0020	
5700K	5667±355	0.0025	
6500K	6532±510	0.0031	
Flexible CCT	T <sub>F</sub> <sup>1)</sup> ± ΔT <sup>2)</sup>	D <sub>uv</sub> T <sub>F</sub> <sup>3)</sup>	

## White Colour Charts

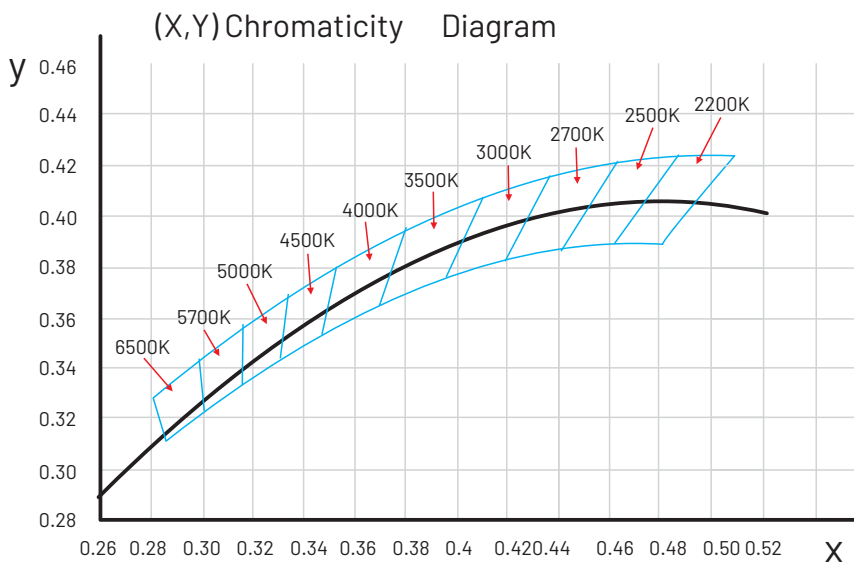

## Photometric

F15A-WW 3000K

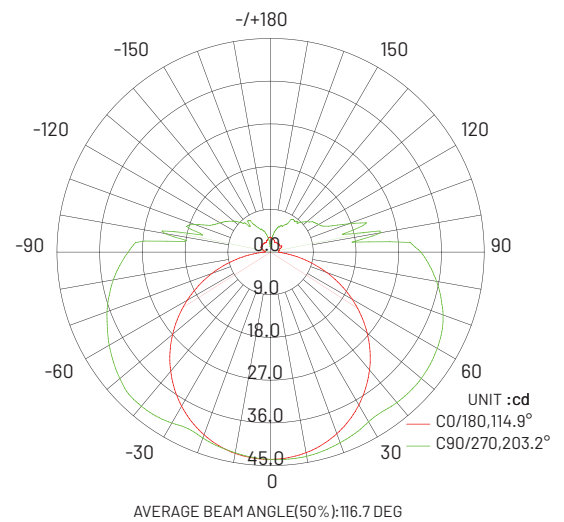

- Please note that it is normal for the PVC material of LED Neon Flex to experience 20-30% yellowing when it is used in direct sunlight, has long term exposure to high temperatures or installed in a wet environment, within 3 years.
- In Regard to the tolerance range of the optical parameters (luminance, CCT, Wattage, RA) for all LED Neon Flex products, there is a 10% fluctuation when referring to the IEC Standard.
- Please note there is a tolerance range for cut lengths of LED Neon Flex. This is due to production technology, environmental parameters, ambient temperatures and installation methods. The tolerance ranges are: 0-5m = ± 7mm, 5-10m = ±15mm, 10-20m = ± 30mm.

### Mounting Channel

FLXNF-026

Use for : Architectural & Pixel Neon

Length : 2m

Material: White Aluminum alloy

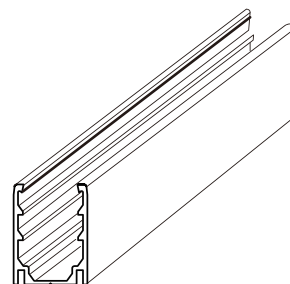
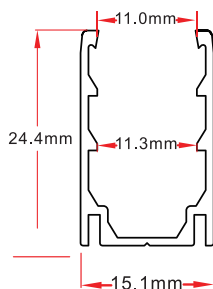

FLXNF-069

Use for : Architectural & Pixel Neon

Length : 1m

Material: Clear PVC

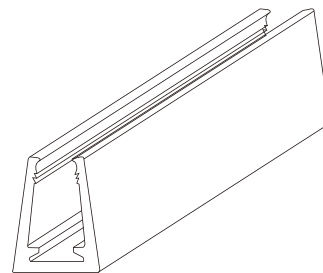
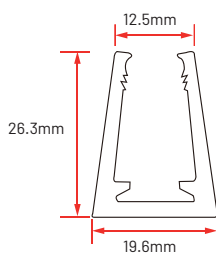

FLXNF-068

Use for : Architectural & Pixel Neon

Length : 1m

Material: Anodised Aluminium

