



Features

- 4 Oz PCB
- CRI 90 LEDs
- 3 Year Warranty
- > 3% Optical Decay
- Energy Efficient

Applications

- Linear lighting
- Cove lighting
- Wayfinding
- Custom Applications
- All Types of Joinery

Dimensions

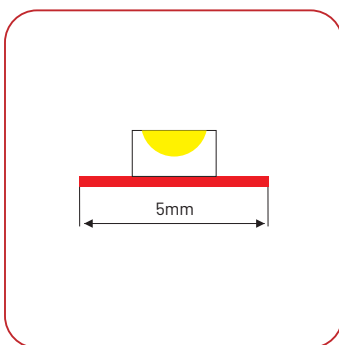

Beam Angle

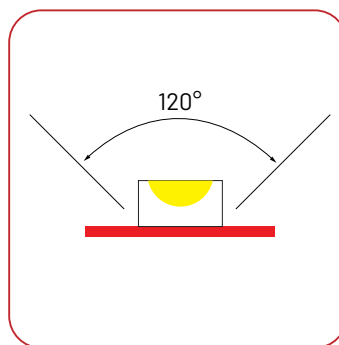

Double Sided Tape

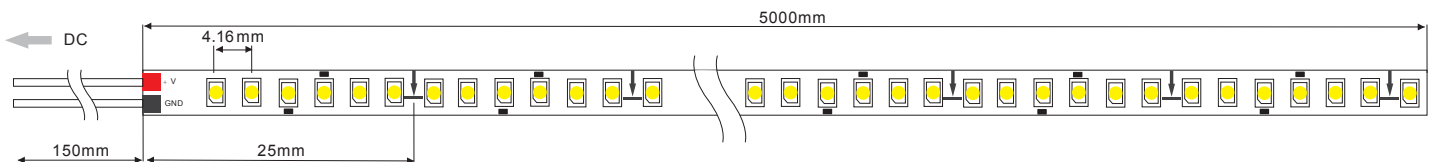
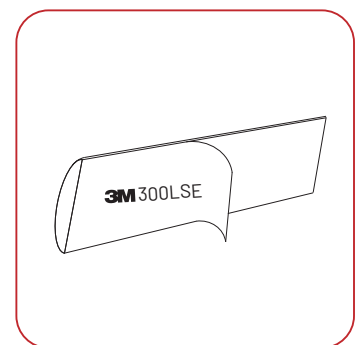

VOLTAGE	24v
POWER CONSUMPTION	10w/pm
LUMEN OUTPUT	1000lm/pm
LED QUANTITY	240LED/pm
WIDTH	5mm

MAX LENGTH	10M (SINGLE FEED)
LIFE SPAN	50,000 HRS
OPERATING TEMP	-20°C~+45°C
IP RATING	IP20
WARRANTY	3 Years

ORDERING INFORMATION

ITEM CODE	FLXST-054	FLXST-055	FLXST-056
COLOUR	3000K	4000K	6000K